

# OSRAM SOLERIQ Family - Details on Handling, Mounting and Electrical Connection

## Application Note

---

### Introduction

This application note provides information on handling and processing the Chip on Board Modules (CoB) from the OSRAM Opto Semiconductors SOLERIQ Family.

This application note contains general advice on mounting the CoB with respect to thermal management, electrical connection and the use of accessories such as optics. It also includes general drive recommendations and details on the correct handling of the CoB itself.

### SOLERIQ Product Characteristics

#### Dimensions and Construction of SOLERIQ Products

SOLERIQ LED products are based on a metal core printed circuit board with several LED chips. The chips are connected with wire bonds and covered with a silicone resin containing phosphorescent and light diffusing particles. Different product versions contain different numbers of LED chips and even different chip technologies, but handling is similar for all SOLERIQ products.

### Application Example

The picture below shows a sample application using a SOLERIQ CoB, e.g. a down- or a spot light.

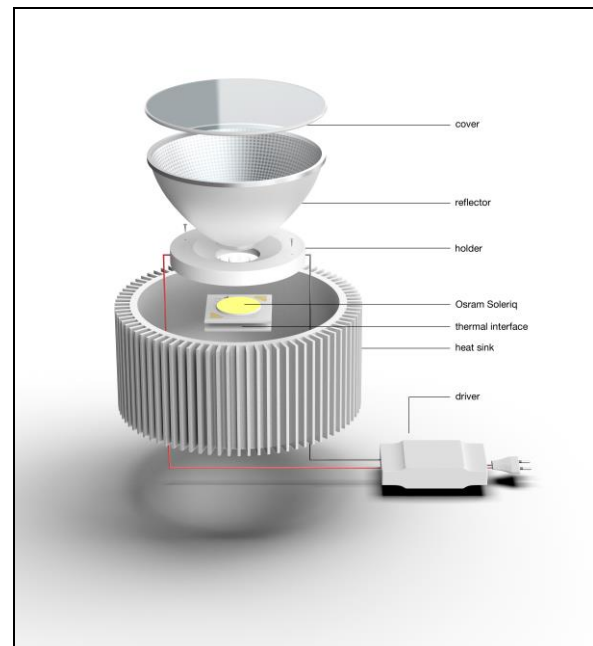

**Figure 1: Application example with a SOLERIQ CoB.**

## Handling

In addition to general guidelines on handling LEDs, special care must be taken to ensure that no mechanical force is applied to the silicone area.

- The LED must not be picked up or handled by the silicone.
- The silicone resin area must not be touched during the assembly process. Any force to the light-emitting surface may cause damage to the wires of the LED array. Damaged wire bonds may lead to early device failure, even if the product shows no immediate change in performance.

When handling, plastic gloves should be used and the CoB held at the sides. Tweezers can be used but the tips must be kept away from the solder pads and the resin area (Figures 2, 3, 4).

In general, all types of sharp objects (e.g. pincers, fingernails, etc.) should be avoided in order to prevent stress to or penetration of the encapsulant, as this can lead to damage of the component.

Care must also be taken to ensure that no other components (e.g. additional optics) in the application are mounted in mechanical contact with sensitive components of the SOLERIQ product.

Avoid contamination of the solder pads and the thermal contact area when handling.

It is also recommended that SOLERIQ LEDs are handled with appropriate ESD protection.

For further information on ESD-compliant handling, please also refer to the “ESD Protection while Handling LEDs” application note.

### GOOD

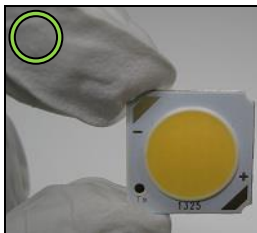

### BAD



Figure 2: Handling with plastic gloves

### GOOD

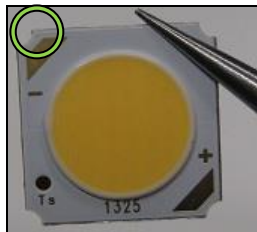

### BAD

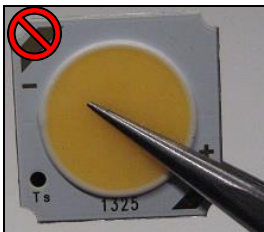
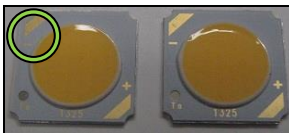

Figure 3: Handling with tweezers

### GOOD



### BAD



Figure 4: Storage of the SOLERIQ product

## Mounting Recommendations

Information on mounting and thermal performance is discussed in this chapter.

In principle there are three different options to mount a CoB:

- Gluing (tape or liquid)
- Screwing the product directly (if screw holes available)
- Connectors
- Simple plastic holders

With the use of gluing, direct screwing and simple plastic holders hand soldering is required, while connectors also provide the electrical connection.

Each option offers advantages and disadvantages.

### Thermal interface

The proper thermal design of an LED luminaire is critical to guarantee optimum performance and a long service life for all components.

The CoB must be mounted with the bottom surface fully on the heat sink.

Depending on the application and the SOLERIQ product chosen, passive cooling may be suitable. In critical applications with restrictions on the heat sink size combined with a high power CoB, active cooling may be needed. Active cooling combines a heat sink with an auxiliary fan or a similar device to maximize the air-mass flow onto the heat sink to maximize its cooling power.

When mounting a CoB, the most important parameter is the thermal interface.

If adhesives are used, e.g. liquid glue or an adhesive tape, they must provide a proper thermal interface.

For efficient thermal transfer from the SOLERIQ product to the heat sink, the two solid surfaces must be brought into close contact using screws, a connector or a holder. Given that the surfaces of both are

never truly flat, a microscopic roughness exists. This leads to air in the cavities between the surfaces. As air is a poor conductor of heat, these gaps should be filled with thermally conductive material to reduce the thermal resistance and to ensure efficient heat flow from the CoB to the heat sink.

Several Thermal Interface Materials (TIM) are available to improve the thermal performance. To optimize thermal performance, the TIM should be thin and have high thermal conductivity.

On the other hand, the TIM must be thick enough to fill the air gaps and it must be possible to compress it where the surfaces come in contact with each other. Thermal grease works well in this case but may be difficult to handle in series production. Thermal pads or tapes are easier to handle but typically cause a thicker thermal interface which in turn causes higher thermal resistance.

We recommend doing thermal tests with different TIM materials to find the optimum solution for the surfaces used in the application.

### Special considerations when screwing the product directly

Some versions of SOLERIQ can be screwed directly on to a heat sink.

Please note that screwing with too high torque can cause the CoB to bend which can have an adverse effect on the thermal interface. Using a torque wrench is thus strongly recommended. Good results have been achieved with torques of 0.1-0.2 Nm using M3 stainless steel screws. The use of washers is also recommended. When using a connector or a holder, please follow the mounting recommendations of the specific manufacturer.

CoBs without screw holes are not designed for direct screwing.

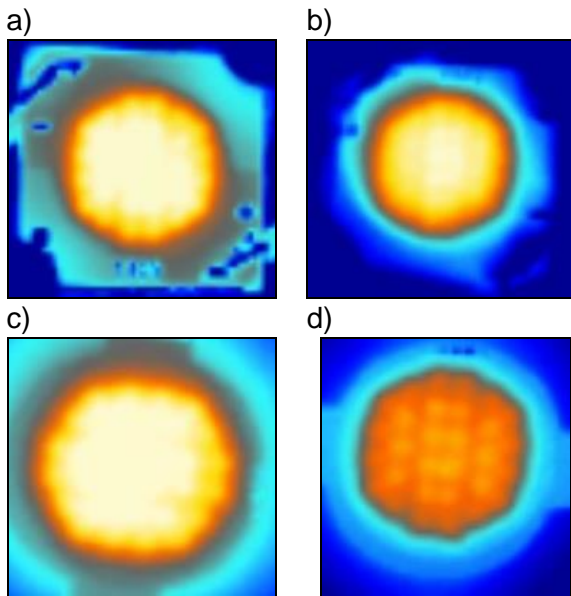
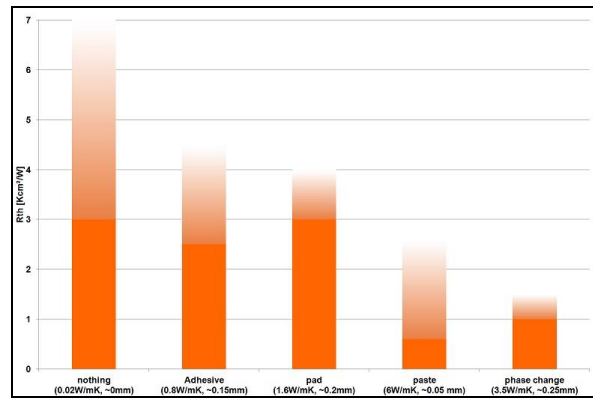

**Figure 5: Thermography with SOLERIQ S 13**

See figure 5 for thermograph pictures of SOLERIQ S 13 with different mounting methods all at 0.1Nm and same temperature scale.

- a) Screwing directly with thermal pad
- b) Screwing directly with thermal grease
- c) Connector with thermal pad
- d) Connector with thermal grease

Looking at the pictures above in more detail, screwing the product directly can result in temperature distribution that is not uniform as there is more pressure on the CoB at the screw position than at the solder pad position. Use of the correct TIM for the appropriate heat sink roughness is highly recommended. A connector or a holder can be used to ensure more homogenous temperature distribution as this will mean the pressure on the CoB is uniform. Moreover, with the correct use of thermal grease better results were achieved compared to thermal pad, but the thin application of grease to merely fill the air gaps can be quite tedious. Furthermore, better results may be achieved particularly for rough surfaces with phase change materials.



**Figure 6: Comparison of different TIMs**

Figure 6 shows typical thermal resistances  $R_{th}$  of some thermal interface materials at typical conditions normalized to 1cm². Taking a closer look you will see that the  $R_{th}$  does not correlate with nominal layer thickness and thermal conductivity. This is due to the different capabilities of the materials to adapt to the surface. Depending on the surface quality (milled v cast v polished), a TIM may perform differently. The capability to equalize a burr is also important.

A general comparison of different mounting methods can be seen in Figure 8.

### Estimating the required heat sink

To estimate the performance (the  $R_{th}$ ) of the cooler for your application, you need to know or define:

- $T_s$
- Maximum ambient temperature  $T_{a \max}$
- Operating current ( $I_f$ )
- Operating voltage ( $V_f$ )
- Efficiency of the LED ( $\eta$ )

As a first step calculate the heat load the heat sink must dissipate:

$$P_{\text{heat}} = I_f * V_f * (1 - \eta)$$

As a second step calculate the temperature drop of the thermal interface:

$$\Delta T_{\text{TIM}} = R_{\text{th TIM}} * P_{\text{heat}}$$

The remaining temperature budget for the heat sink is:

$$\Delta T_{\text{cooler}} = T_S - T_{a \text{ max}} - \Delta T_{\text{TIM}}$$

You need a heat sink with a maximum  $R_{\text{th}}$  of:

$$R_{\text{th}} = \Delta T_{\text{cooler}} / P_{\text{heat}}$$

Example for SOLERIQ S 19:

$$\begin{aligned} T_S &= 85 \text{ }^\circ\text{C} \\ T_{a \text{ max}} &= 40 \text{ }^\circ\text{C} \\ V_f &= 46.5 \text{ V} \\ I_f &= 0.7 \text{ A} \\ \eta &= 35 \% \end{aligned}$$

$$\begin{aligned} P_{\text{heat}} &= 46.5\text{V} * 0.7\text{A} * (1-0.35) \\ &= 21.2 \text{ W} \end{aligned}$$

The datasheet for a common thermal pad has rates of 1.42 Kcm<sup>2</sup>/W, the SOLERIQ S19 has a surface of 24\*24mm<sup>2</sup>.

$$R_{\text{th TIM}} = 1.42 \text{ Kcm}^2/\text{W} / 2.4^2 \text{ cm}^2 = 0.25 \text{ K/W}$$

$$\Delta T_{\text{TIM}} = 0.25 \text{ K/W} * 21.2 \text{ W} = 5.2 \text{ K}$$

$$\begin{aligned} \Delta T_{\text{cooler}} &= 85 \text{ }^\circ\text{C} - 40 \text{ }^\circ\text{C} - 5.2 \text{ K} \\ &= 39.8 \text{ K} \sim 40 \text{ K} \end{aligned}$$

$$\begin{aligned} R_{\text{th cooler}} &= 40 \text{ K} / 21.2 \text{ W} \\ &= 1.9 \text{ K/W} \end{aligned}$$

A cooler with a maximum of 1.9K/W is needed to keep a SOLERIQ S19 with 3000lm below  $T_S = 85 \text{ }^\circ\text{C}$  at an ambient temperature of 40°C.

In all cases, the thermal design must be verified by testing a prototype.

To do this, the case temperature must be measured within the planned ambient and operating conditions. The case temperature ( $T_S$ ) can be measured at the designated case temperature measurement point given in the datasheet. This measurement point is shown for the SOLERIQ S Family in figure 7.

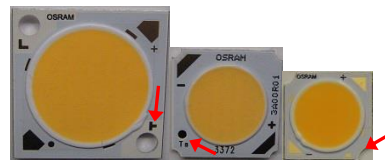

**Figure 7:  $T_S$  measurement point of a SOLERIQ S 19, S 13 and S 9**

Once the  $T_S$  has been measured, the value can be used to calculate the junction temperature:

$$T_j = P_{\text{heat}} * R_{\text{th,JS,real}} + T_S$$

The junction temperature can be calculated with the  $R_{\text{th}}$  of the LED given in the relevant datasheet,

OSRAM Opto Semiconductors recommends attaching the thermocouple using thermally conductive glue or by soldering.

For further information on temperature measurement, please refer to the "Temperature Measurement with Thermocouples" application note.

All materials used for casting the luminaire or for the thermal interface must be checked for chemical compatibility with the specific manufacturer. The suitability of the thermal material and heat sink material must be guaranteed.

Moreover, gas tight casting of the CoB LED must be avoided in order to minimize the interaction of the CoB with the outgassing of potentially critical materials.

Technique	Glue			Screw			Holder		
Material	Liquid glue	Tape	None	Thermal grease	TIM foil	None	Thermal grease	TIM foil	
<b>Thermal performance</b>	o.. +	-.. o	+	++	+	+	++	o.. +	
<b>Effort when handling</b>	-	+	o	--	o.. +	++	-	+	
<b>Process stability</b>	-	+	-	o	+	++	+	++	
<b>Cost</b>	++	o	+	+	-	+	o	-	
<b>Failure proof</b>	+	++	-	++	++	-	++	++	
<b>Remark</b>	Correct process necessary to achieve stable results with good thermal performance	Preshaped tapes make it easy	Bending of CoB possible due to high torque => worsens thermal performance. Surface quality is important for thermal performance	Bending of CoB possible due to high torque => worsens thermal performance	Bending of CoB possible due to high torque => worsens thermal performance	Surface quality is important for thermal performance	Excessive paste covered by the holder		
<b>Challenges</b>	Achieve low bondline thickness without voids and excessive glue which causes handling problems	Apply enough pressure to the CoB without damaging it	Clean and even surfaces	Avoid contamination caused by excessive paste		Clean and even surfaces			
<b>Processing</b>	Good results with screen-printing or dispense robot.  Manual dispensing is less repeatable. Risk of voids or bondline that is too thick	Tool for pushing the CoB onto the tape recommended	Use torque screwdriver	Use torque screwdriver.  Good results with screen-printing or dispense robot.  Manual dispensing is less repeatable. Risk of voids or bondline that is too thick. Excessive paste results in contamination of product and equipment/operator	Use torque screwdriver	Use torque screwdriver	Use torque screwdriver. Good results with screen-printing or dispense robot.	Use torque screwdriver	

**Figure 8: Comparison of different mounting methods**

## Soldering

The recommended soldering process is manual soldering. SOLERIQ products are not suited to reflow soldering.

To be RoHS-compliant, use lead-free soldering.

When selecting the tip for the soldering iron, choose the optimum size and type for the component used (Figure 9). Good results have been achieved with a chisel-formed tip with a maximum width of the solder pad length.

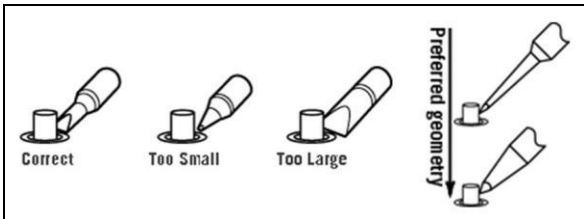

**Figure 9: Tip selection - correct type for each application**

The maximum wire diameter is related to the maximum current of the relevant CoB. Wires with smaller diameter are used, depending on the chosen forward current; please check that with the wire supplier. The wire strip length depends on the size of the SOLERIQ LED and should be no longer than the length of the solder pad.

Prepare the wire/solder in accordance with IPC-A-610D, Chapter 6.3. The stripped wire (lead) should be protected with a thin layer of solder (Figure 10).

In order to avoid problems when mounting the device, the solder used should consist of the same alloy as the pre-tinned solder pads.



**Figure 10: Pre-tinned solder pads and wires**

After soldering the stripped wire must not be outside the area of the solder pad; otherwise a short circuit may occur via the aluminum board (Figure 11).

**GOOD**



**BAD**



**Figure 11: Soldering of SOLERIQ product**

Due to the very low thermal resistance of OS CoBs, heat will quickly dissipate from the solder pads while soldering. To reduce the solder process time, use an additional temperature-controlled heating plate to ensure a constant temperature during the soldering process.

It is recommended to solder the CoB before mounting to the heat sink. Otherwise, the heat which is necessary for the soldering process will dissipate to the heat sink and the process time will be extended.

When evaluating the soldering process, for example, you should always start with the lowest temperature; the temperature of the soldering tip should not exceed 350°C.

When soldering one pad, a maximum contact time of 3 seconds should not be exceeded.

The temperature of the complete CoB, and in particular the LES, should not exceed 150°C.

For further information on manual lead-free soldering see also the "Manual Lead-free Soldering of LEDs" application note.

## Accessories

### Connectors

To fasten the CoB mechanically onto the heat sink, you can either screw it or glue it on. However, manual soldering is needed afterwards. As an alternative, the CoB can be attached mechanically to the heat sink using connectors. These connectors will also provide the electrical contact at the same time with push-in terminals for the cables.

A clamping feature for the LED is commonly used when fixing the LED onto the connector during mounting. Moreover, most connectors offer mounting features for secondary optics.

Please refer to the datasheet/webpage of the specific manufacturer for the recommended maximum torque of the screws and the wire size if using a connector.

Several opto-electrical manufacturers have developed or are currently developing connectors to simplify mechanical and electrical connection of SOLERIQ products.

Company	Webpage
BJB	<a href="http://www.bjb.com">www.bjb.com</a>
Molex	<a href="http://www.molex.com">www.molex.com</a>
A.A.G. STUCCHI	<a href="http://www.aagstucchi.it">www.aagstucchi.it</a>
TE Connectivity	<a href="http://www.te.com">www.te.com</a>
IDEAL	<a href="http://www.idealindustries.com">www.idealindustries.com</a>
Bender + Wirth	<a href="http://www.bender-wirth.com">www.bender-wirth.com</a>

Table 1 shows an overview of part numbers of available connectors and table 2 shows the available simple plastic holders without electrical connection for SOLERIQ CoB. Each part number gives a link to additional information on the connector and its use.

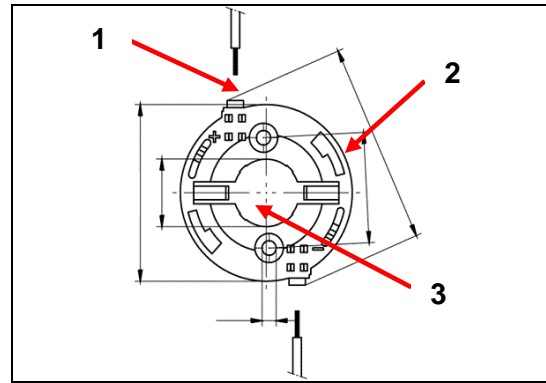

**Figure 12: Sample connector from BJB with push-in for the cables (1), mounting feature for secondary optics (2) and a clamping feature for the LED (3).**

### Secondary optics

The radiation characteristic of SOLERIQ products is lambertian. If a viewing angle narrower than  $120^\circ$  is required, secondary optics are required. To collect all light from the SOLERIQ LED, the secondary optics must be large enough to cover the complete LES. For example, a reflector must be mounted on the CoB outside the white ring that surrounds the yellow resin. Do not use the white ring for mechanical alignment of the secondary optics. Otherwise, the LED array might get damaged (Figure 13).

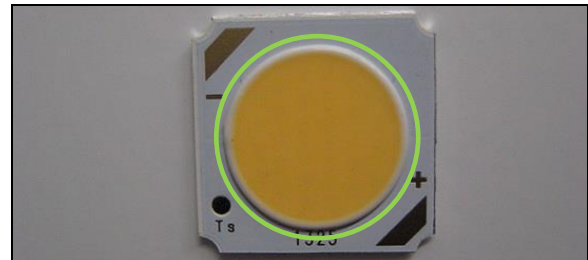

**Figure 13: Secondary optics must be mounted outside the white ring.**

There are many manufacturers who provide off-the-shelf lenses or reflectors for SOLERIQ products, see some reference optics in Table 2 and Table 3.



SOLERIQ LED	BJB	TE	A.A.G. STUCCHI	Molex	Ideal	Bender + Wirth
S 9 (13.5mmx13.5mm)	<a href="#">47.319.6060.50</a> 47.319.6294.50 47.319.6295.50	2213678-5 2213678-6 <a href="#">6-2154874-1</a> 2-2154857-1		<a href="#">1804140001</a> <a href="#">1804140102</a>	50-2002CT	434 Type 1 434 Type 2
S 13 1 <sup>st</sup> gen (18x18mm)	<a href="#">47.319.6111.50</a>	<a href="#">2213401-1</a> <a href="#">2213401-2</a> <a href="#">2-2154857-2</a>	<a href="#">8502-G2</a>		50-2101CR	<a href="#">437</a>
S 13 2 <sup>nd</sup> /3 <sup>rd</sup> gen (19x19mm)	<a href="#">47.319.2025.50</a> <a href="#">47.319.2021.50</a> <a href="#">47.319.2026.50</a>	2213254-1 2213254-2 6-2154874-2 2-2154857-2	<a href="#">8101/G2</a>	<a href="#">1804140001</a> <a href="#">1804140103</a>	50-2103CT	<a href="#">477</a>
S 19 (24mmx24mm)	<a href="#">47.319.2170.50</a>	<a href="#">2213407-1</a> <a href="#">2213407-2</a> <a href="#">5-2154874-3</a> <a href="#">2-2154857-3</a>	<a href="#">8503-G2</a>	<a href="#">180810-0001</a>		<a href="#">462</a>

**Table 1: SOLERIQ connector part numbers**

SOLERIQ LED	Simple plastic holder
S 9 (13.5mmx13.5mm)	Darkoo DK1313-FS-B
S 13 1 <sup>st</sup> gen (18x18mm)	Darkoo DK1818-14-FS-B
S 13 2 <sup>nd</sup> /3 <sup>rd</sup> gen (19x19mm)	Darkoo DK-S13-FS-B
S 19 (24x24mm)	Darkoo DK-S19-FS-B

**Table 2: Overview of simple plastic holders for SOLERIQ CoB**

Table 3 shows an overview of some of the available optics, which can be directly mounted onto the connector with e.g. some twist-and-lock function.

For more optics without regard to mounting feature, see Table 5.

SOLERIQ LED	Connector Vendor	Connector Part No	Optic part number					
			Ledil	Gaggione	Carclo	Kathod	Almecco	BJB
S 9 (13.5x 13.5mm)	BJB	47.319.6060.50						47.940.- 311/312/313
	Bender + Wirth	434	Barbara/Mirella (Typ L1)					
S 13 2 <sup>nd</sup> /3 <sup>rd</sup> gen (19x19mm)	BJB	47.319.2025.50 47.319.2021.50	Angela-x-B Angelina-x-B	LLR07M LLR27M		KCLP1429ST- KCLP1433ST*		
	A.A.G. STUCCHI	8101/G2	Angela-x-B Angelina-x-B			KCLP1429ST- KCLP1433ST*	Evo74n/m/ w/xw	
	TE	2213254-2	Angela-x Angelina-x Angelette-WAS with metal clip 2213194-1		12684 12685	KCLP1429ST KCLP1430ST KCLP1431ST KCLP1432ST KCLP1433ST With metal clip 2213349-1		
	Ideal	50-2103CT	Lena/Lenina (with optic adapter 50- 2100LN) Angela/Angelina (with optic adapter 50-2100AN)					
	Molex	1804140001 1804140103						
	Bender + Wirth	477	Angela-x Angelina-x Angelette-x (Typ L1)	LLR01N (Typ G1)	12796 (Typ C1)			108n 108w (Typ A1)

\* With Kathod optic adapter KE1784

SOLERIQ LED	Connector Vendor	Connector Part No	Optic part number					
			Ledil	Gaggione	Carclo	Kathod	Almecco	BJB
S 13 1 <sup>st</sup> gen (18x18mm)	BJB	<a href="#">47.319.6111.50</a>				<a href="#">KCLP1429ST-</a> <a href="#">KCLP1433ST*</a>	75n***	<a href="#">47.940</a> - <a href="#">351.56</a> <a href="#">47.940</a> - <a href="#">352.56</a>
	A.A.G. STUCCHI	<a href="#">8502-G2</a>	<a href="#">Angela-S/M/W-B</a> <a href="#">Angelina-S/M/W-B</a>				75n***	
	TE	<a href="#">2213401-2</a>	<a href="#">Angela-S/M/W</a> <a href="#">Angelina-S/M/W</a> with metal clip <a href="#">2213194-1</a>		<a href="#">12684</a> <a href="#">Newton M</a> <a href="#">12685</a> <a href="#">Newton W</a>	<a href="#">KCLP1429ST</a> <a href="#">KCLP1430ST</a> <a href="#">KCLP1431ST</a> <a href="#">KCLP1432ST</a> <a href="#">KCLP1433ST</a> With metal clip <a href="#">2213349-1</a>		
	Ideal	50-2101CR	Mirella-S/M/W-PF (with 50-2100MR) Lena (with 50-2100LN) Angela & Angelina (with 50-2100AN)					
	Bender + Wirth	<a href="#">437</a>	Angela/Angelina Angelette/ Winnie/Stella Lena/Lenina Mirella/Barbara with Ledil plastic adapter		<a href="#">12684</a> <a href="#">Newton M</a> <a href="#">12685</a> <a href="#">Newton W</a> with Carclo plastic adapter		108n/108w DKL97/DKL194 DKL-SQ120	
S 19 (24x24mm)	BJB	<a href="#">47.319.2170.50</a>	<a href="#">Angela-S/M/W-B</a> <a href="#">Angelina-S/M/W-B</a>	<a href="#">LLR07M2</a> <a href="#">2AA0</a> <a href="#">LLR27M2</a> <a href="#">2AA0</a>		<a href="#">KCLP1429ST</a> <a href="#">KCLP1430ST</a> <a href="#">KCLP1431ST</a> <a href="#">KCLP1432ST</a> <a href="#">KCLP1433ST**</a>	<a href="#">Evo74n/m/w/xw</a> <a href="#">Evo106m/w</a> <a href="#">108n/w</a> <a href="#">(V98D80)</a>	
	A.A.G. STUCCHI	<a href="#">8503-G2</a>	<a href="#">Angela-S/M/W-B</a> <a href="#">Angelina-S/M/W-B</a>				<a href="#">Evo74n/m/w/xw</a> <a href="#">Evo106m/w</a>	
	TE	<a href="#">2213407-1</a> <a href="#">2213407-2</a>	<a href="#">Angela-S/M/W</a> <a href="#">Angelina-S/M/W</a> with metal clip <a href="#">2213194-1</a>					
	Bender + Wirth	<a href="#">462</a>	Angela/Angelina Angelette/ Winnie/Stella Lena/Lenina Mirella/Barbara with Ledil plastic adapter		<a href="#">12684</a> <a href="#">Newton M</a> <a href="#">12685</a> <a href="#">Newton W</a> with Carclo plastic adapter		108n/108w DKL97/DKL194 DKL-SQ120	

\* With Kathod optic adapter KE1784

\*\* With Kathod optic adapter KE1782

\*\*\* Customization on demand

**Table 3: SOLERIQ connectors and directly mountable optics**

If you wish to design your own secondary optics or analyze your optical system, ray files containing all optical characteristics of the specific LED are provided on our website <http://catalog.osram-os.com/> (click Applications/Ray Files).

### Drivers

A number of manufacturers offer electronic solutions to drive SOLERIQ products. Their portfolio covers a diverse range, e.g. drivers with fixed constant current output to intelligent, dimmable devices.

Company	Webpage
OSRAM OPTOTRONIC	<a href="http://www.osram.de/optotronic">www.osram.de/optotronic</a>
ROAL ELECTRONICS	<a href="http://www.roallivingenergy.com">www.roallivingenergy.com</a>
RECOM Lighting	<a href="http://www.recom-lighting.com">www.recom-lighting.com</a>
Inventronics	<a href="http://www.inventronics-co.com">www.inventronics-co.com</a>

### Thermal Accessoires

Many thermally conductive pastes, foils and compounds with different thermal resistance and different requirements for careful

handling are available; see some examples in table 4.

Many manufacturers provide solutions for thermal interface materials (TIM) and for passive or active cooling depending on the power class and the specific application.

Active and passive cooling solutions:

Company	Webpage
Fischer Elektronik	<a href="http://www.fischerelektronik.de">www.fischerelektronik.de</a>
Wisefull Technology	<a href="http://www.wisefull.com">www.wisefull.com</a>
Sarnikon	<a href="http://www.sarnikon.com">www.sarnikon.com</a>
MechaTronix	<a href="http://www.led-heatsink.com">www.led-heatsink.com</a>
Cooler Master	<a href="http://www.coolermaster.com">www.coolermaster.com</a>
Sunon	<a href="http://www.sunon.com">www.sunon.com</a>
ELR	<a href="http://www.elr-group.com">www.elr-group.com</a>

TIM solutions:

Company	Webpage
Bergquist	<a href="http://www.bergquistcompany.com">www.bergquistcompany.com</a>
DENKA	<a href="http://www.denka.co.jp">www.denka.co.jp</a>
TTM	<a href="http://www.coolttm.com">www.coolttm.com</a>
Laird	<a href="http://www.lairdtech.com">www.lairdtech.com</a>

Supplier	Thermal pad	Thermal grease	Thermal adhesive tape	Thermal liquid adhesive	Thermal phase change material	Thermal gap filler
Bergquist	<a href="#">Sii-Pad 1500ST</a>	<a href="#">TIC 1000A</a>	<a href="#">Bond-Ply® 800</a>	<a href="#">Liqui-Bond® SA 3505</a>	<a href="#">Hi-Flow 565U</a>	<a href="#">Gap Filler 4000</a>
Denka	<a href="#">SPACER Pad</a>	<a href="#">SPACER Grease</a>	<a href="#">ELE THERMAL</a>		<a href="#">SPACER Phase Change</a>	
TTM	<a href="#">NANOTIM® SPS</a>	<a href="#">NANOTIM® TGS</a>			<a href="#">NANOTIM® PCM</a>	
Laird	<a href="#">Tgard™ / Tgon™</a>	<a href="#">Tgrease™</a>			<a href="#">Tpcm™ / Tmate™</a>	<a href="#">Tpli™ / Tflex™ / Tputty™</a>
3M	<a href="#">5590H</a>	<a href="#">Grease TCG-2035</a>	<a href="#">8810</a>	<a href="#">TC-2810</a>		

**Table 4: Examples for thermal interface materials**

You will find a large number of partners offering accessories on the website of the “LED Light for you” network.

The network provides details on experts for optical-, thermal- and electrical management as well as system integration partners. It supports you and your customer in the implementation of your idea...be it for a component, partial project or complete solution.

You can find more accessories for the SOLERIQ products like secondary optics, connectors, thermal solutions and drivers by visiting the LLFY Selector App:

<http://www.ledlightforyou.com/Services/en-App.php>

The LLFY Selector App can be used on smartphones, tablets with an iOS or Android operating system and it is also available in a desktop version.

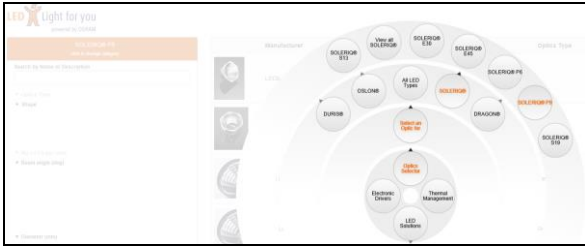

**Figure 14: Example for an easy search for available accessories for a SOLERIQ product with the LLFY Selector App.**

## Optical considerations

### Optical mounting

There are several options to attach secondary optics to SOLERIQ products:

- Fix the optics within the luminaire housing and attach them on top of the SOLERIQ CoB.
- Attach the optics on top of a connector with e.g. a twist-and-lock function.
- Some optics are supplied with a holder which can be directly applied on the SOLERIQ.

### Optical manufacturers

There are many LED optical manufacturers around the world to offer optical solutions for SOLERIQ LEDs. Table 5 shows some examples of optics solutions from different optical manufacturers to have a first reference for designing an optical system.

Optical manufacturer	SOLERIQ LED	Beam Angle FWHM			Link
		< 15°	15 – 30°	> 30°	
Ledil	S 9 (13.5x13.5mm)		Mirella-S-PF Mirella-M-PF Winnie-S	Mirella-W-PF Winnie-M Winnie-W	<a href="http://www.ledil.com">www.ledil.com</a>
	S 13 2 <sup>nd</sup> /3 <sup>rd</sup> gen (19x19mm)	Angela-S	Angela-M Angelina-S	Angela-W/XW Angelina-M/W/XW	
	S 13 1 <sup>st</sup> gen (18x18mm)	Angela-S	Angela-M/W Angelina-S Mirella-S-PF	Angelina-M/W Saga Mirella-M/W-PF	
	S 19 (24x24mm)	Angela-S	Angelina-S Angela-M	Angelina-M/W Angela-W	

Optical manufacturer	SOLERIQ LED	Beam Angle FWHM			Link
		< 15°	15 – 30°	> 30°	
Gaggione	S 9 (13.5x13.5mm)	LLR05N	LLC15M LLC56N LLC66N7 LLC66M7 LLR01N LLR05NxLLD05M1	LLC05M LLC05W LLC15W LLR01NxILLD01M1 LLR01NxLLD01S1 LLR05NxLLD05S1	<a href="http://www.lednlight.com">www.lednlight.com</a>
	S 13 2 <sup>nd</sup> /3 <sup>rd</sup> gen (19x19mm)	LLR27M	LLC56N7 LLR05N LLR07M	LLC15W	
	S 13 1 <sup>st</sup> gen (18x18mm)	LLC56N LLR01N LLR05N	LLR01N LLR05N		
	S 19(24x24mm)		LLR07M22AA0 LLR27M22AA0		
Kathod	S 9 (13.5x13.5mm)				<a href="http://www.khatod.com">www.khatod.com</a>
	S 13 2 <sup>nd</sup> /3 <sup>rd</sup> gen (19x19mm)	KCLP1858CR	KCLP1429ST KCLP1430ST	KCLP1431ST KCLP1432ST KCLP1433ST	
	S 13 1 <sup>st</sup> gen (18x18mm)		KCLP1429ST KCLP1430ST PL50SIL	KCLP1431ST KCLP1432ST KCLP1433ST	
	S 19 (24x24mm)		KCLP1429ST	KCLP1430ST KCLP1431ST KCLP1432ST KCLP1433ST	
Carclo	S 9 (13.5x13.5mm)				<a href="http://www.carclo-optics.com">www.carclo-optics.com</a>
	S 13 2 <sup>nd</sup> /3 <sup>rd</sup> gen (19x19mm)		12684 Newton M	12685 Newton W	
	S 13 1 <sup>st</sup> gen (18x18mm)		12684 Newton M	12685 Newton W	
	S 19 (24x24mm)			12684 Newton M 12685 Newton W	
Alux Luxar	S 13 2 <sup>nd</sup> /3 <sup>rd</sup> gen (19x19mm)				
	S 13 1 <sup>st</sup> gen (18x18mm)	PLC 6900 PLC 7500 PLC 7800 PLC 7900	PLC 7000 PLC 7100 PLC 7200 PLC 7300 PLC 7400 PLC 7600 PLC 7700 PLC 8000	PLC 8100	
	S 19 (24x24mm)	PLC 10600	PLC 9600 PLC 9700 PLC 9800 PLC 9900 PLC 10000 PLC 10100 PLC 10200 PLC 10300 PLC 10400 PLC 10700	PLC 10500 PLC 10800	

Optical manufacturer	SOLERIQ LED	Beam Angle FWHM			Link
		< 15°	15 – 30°	> 30°	
Almecco	S 9 (13.5x13.5mm)		108n	108w	<a href="http://www.almecogroup.com/en">www.almecogroup.com/en</a>
	S 13 (18x18mm) & (19x19mm)		Evo74n 108n Evo106n	Evo74m/w/xw 108w	
	S 19 (24x24mm)		Evo74n Evo106m 108n	Evo74m/w/xw Evo106w 108w	
Darkoo	S 9 (13.5x13.5mm)	DK5812-H32-Z	DK3530-JC DK4224-JC DK4524-JC DK5024-JC DK6924-JC DK4720-JC DK4730-JC DK4740-JC	DK3540-JC DK3560-JC DK4238-JC-B DK4238-JC DK4260-JC DK4538-JC DK4560-JC DK4560-JC-Z	<a href="http://www.darkoo.cc">www.darkoo.cc</a>
	S 13 2 <sup>nd</sup> /3 <sup>rd</sup> gen (19x19mm)				
	S 13 1 <sup>st</sup> gen (18x18mm)	DK9212-R&L DK7514-R&L-B DK8512-R&L-B	DK9224-R&L DK6916-R&L-B		
	S 19 (24x24mm)			DK5038-REF-B DK90638-JC DK90660-JC	
Nata	S 13 2 <sup>nd</sup> /3 <sup>rd</sup> gen (19x19mm)				<a href="http://www.nata.cn">www.nata.cn</a>
	S 13 1 <sup>st</sup> gen (18x18mm)	2934-E			
	S 19 (24x24mm)		3-1097-E 4-1500-E 4-1501-E	3-1099-E 3-1098-E 4-1407-E	

**Table 5: Secondary optics for SOLERIQ CoB**

## General Electrical Drive recommendations

### Driver information

The light output of an LED corresponds to the forward current. OSRAM Opto Semiconductors recommends operating CoBs with constant current ECGs (electric control gear) to maintain a constant light output from the system. Do not apply reverse voltage to the CoB.

The selected driver device must meet the input requirements specified by the user (110V AC / 220V AC input) as well as the output requirements. For example, the range of  $V_{out}$  (DC),  $I_{out}$  (DC) and electrical power must be checked. Moreover, it is the responsibility of the luminaire designer to ensure that the chosen driver fulfils all the local regulatory requirements.

### Precautions for inrush current

If you switch on a power supply on the output side while the input side is on, an immediate inrush current may occur. These inrush currents can damage the LED so they must be avoided in all circumstances.

Only a small number of power supplies can handle hot plug-in. The majority uses large output capacitors to eliminate the current ripple without an additional current peak limiter which can harm the CoB.

Therefore, OSRAM Opto Semiconductors recommends that you avoid inrush currents by not switching on the output side while the input side is powered unless there are other current limiter precautions in place and verified by measurements. In any case, the maximum surge current must not be exceeded to ensure proper operation of the device.

### Multiple array circuit design

For some luminaire designs, it may be desired to drive more CoB LEDs with one power supply. If using a single power supply with one output channel for constant current mode, series connection of all CoB LEDs is

recommended. This guarantees the same current and therefore the same brightness for all CoB LEDs.

The luminaire designer must ensure that the driver can operate at the resulting forward voltage for the specific current. Moreover, ensure that the luminaire still complies with electrical regulations (SELV etc.) with the resulting higher voltages on the output side of the power supply.

Use a proper electrically isolated TIM in the case of serial connection.

### Ripple

The ripple of an LED power supply is the unwanted residual periodic variation of the direct current output after conversion from AC to DC by the driver. The residual ripple of the various drivers differs – values from 5% to 40% are common. For some sensitive applications, a DC output with low ripple (< 10%) is required to ensure very stable light of a high quality.

Please ensure that the peak forward current (including ripple) does not exceed the maximum current specified in the relevant datasheet.

### Dimming

An adjustable light intensity is necessary in some applications. PWM dimming of the CoB is recommended as current dependency exists among several LED parameters. If dimming is achieved by adjusting the DC-current, a chromaticity coordinate shift occurs which may be detected in sensitive applications. With a PWM-controlled system, only one current level is used. The light intensity is adjusted by switching the current on/off periodically with a specified duty cycle and frequency.

As the response of the human eye is not linear, a linearization of the brightness can also be achieved via PWM control by increasing the duty cycle exponentially (Figure 19).



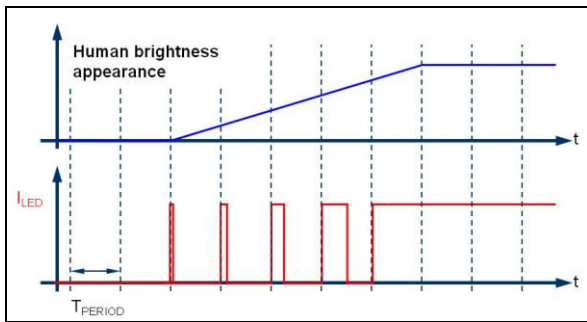

**Figure 19: Exponential PWM control for linear increase in brightness.**

The frequency of the PWM control should be above 300Hz to avoid noticeable flickering to the human eye. PWM frequencies up to 1 kHz are applicable for switching mode drivers and around 10 kHz for linear drivers.

For certain applications, such as rotating parts or for camera illumination, some frequencies are suitable and some are not applicable.

## Conclusion

The intention of the methods for mounting and electrical connection and optical considerations described above is to provide concepts or examples which show the basic design and principal process.

In all cases, the luminaire design must be verified by testing a prototype.

OSRAM OPTO Semiconductors is able to support its customers during their development and design processes in finding the best solution for their specific applications.

For further information or application support, please contact your sales representative or OSRAM Opto Semiconductors.

## Appendix



**Don't forget:** LED Light for you is your place to be whenever you are looking for information or worldwide partners for your LED Lighting project.

[www.ledlightforyou.com](http://www.ledlightforyou.com)

Authors: Alfons Siedersbeck, Dr. Roland Schulz, Alexander Wilm, Manfred Scheubeck, Horst Varga, Kurt-Jürgen Lang

### **ABOUT OSRAM OPTO SEMICONDUCTORS**

OSRAM, Munich, Germany is one of the two leading light manufacturers in the world. Its subsidiary, OSRAM Opto Semiconductors GmbH in Regensburg (Germany), offers its customers solutions based on semiconductor technology for lighting, sensor and visualization applications. Osram Opto Semiconductors has production sites in Regensburg (Germany), Penang (Malaysia) and Wuxi (China). Its headquarters for North America is in Sunnyvale (USA), and for Asia in Hong Kong. Osram Opto Semiconductors also has sales offices throughout the world.

For more information go to [www.osram-os.com](http://www.osram-os.com).

### **DISCLAIMER**

All information contained in this document has been collected, analyzed and verified with great care by OSRAM Opto Semiconductors GmbH. However, OSRAM Opto Semiconductors GmbH is not responsible for the correctness and completeness of the information contained in this document and OSRAM Opto Semiconductors GmbH cannot be made liable for any damage that occurs in connection with the use of and/or reliance on the content of this document. The information contained in this report represents the state of knowledge as of [August 2016].